

GROVE®

GMK6250-L



ALL TERRAIN HYDRAULIC CRANE

Dimensions

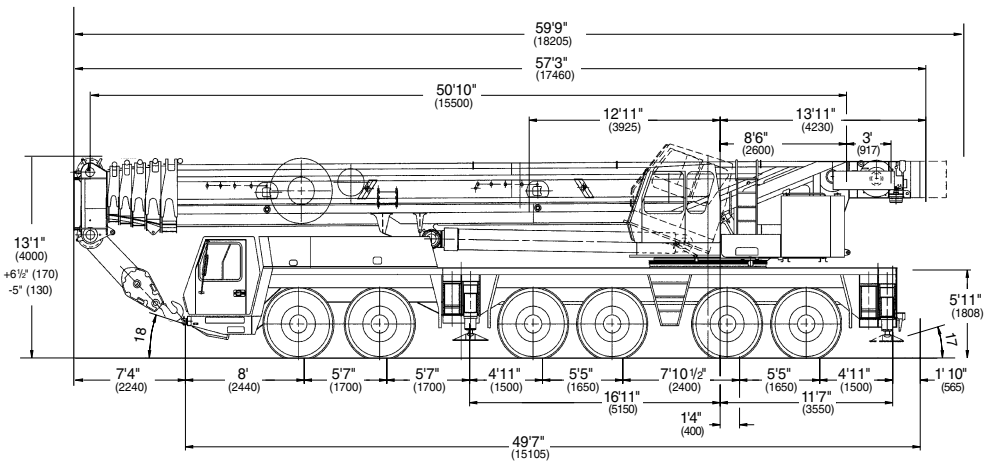
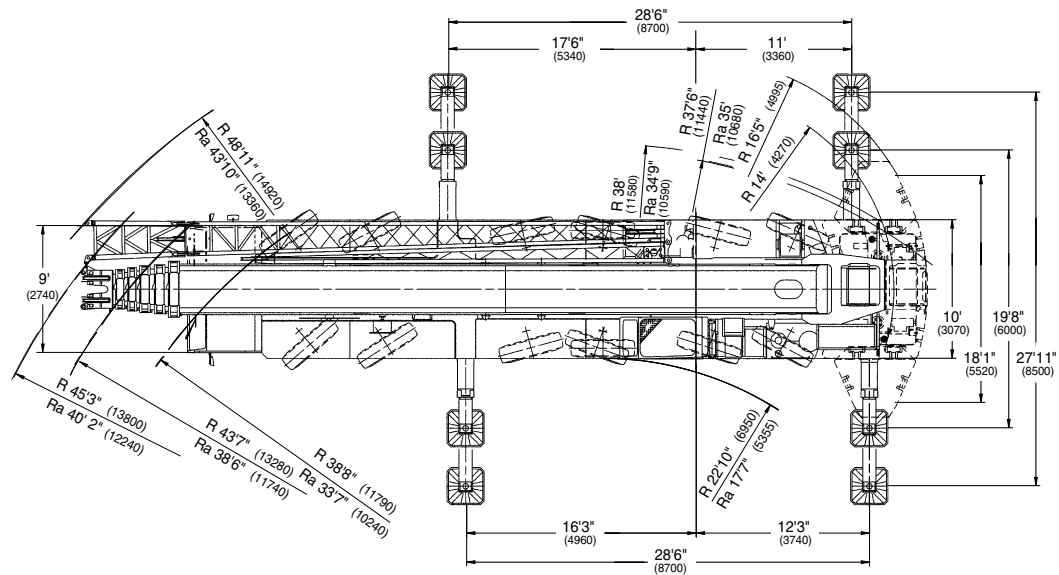

Note: () Reference dimensions in mm

BASIC WEIGHTS (LBS.)	Axles 1 & 2	Axles 3 - 6	Total
With Cummins Power, 20.5 R25 Tires (12x6x12)	46,305	101,775	148,080
With Mercedes Power, 20.5 R25 Tires (12x6x12)	47,140	98,294	145,434
Additions:			
Outrigger Pads	0	772	772
Auxiliary Hoist	-(2,892)	6,618	3,726
Additional Hydraulic Oil Cooler (Standard)	-(55)	143	88
Brackets & Hydraulic Reeling Drum for Lattice Extension	485	22	507
Lattice Extension - 43/72 ft	6,997	-(1,530)	5,467
Spare Tire - 14.00 R25	-(425)	1,010	584
Spare Tire - 16.00 R25	-(522)	1,239	717
Spare Tire - 20.5 R25	-(593)	1,402	809
Boom Removal Equipment (Standard)	53	212	265
12x8x12 drive	966	-(106)	860
Removal:			
Front Outrigger Beams & Jacks	-(3,377)	-(1,980)	-(5,357)
Rear Outrigger Beams & Jacks	3,732	-(9,652)	-(5,919)
Boom Assembly (minus lift cylinder)*	-(29,972)	-(20,889)	-(50,861)
Lift Cylinder*	-(1,457)	-(3,018)	-(4,475)
16.00 R25 Tires in lieu	-(370)	-(741)	-(1,111)
14.00 R25 Tires in lieu	-(899)	-(1,799)	-(2,698)
Rear Outrigger Box (Cummins only)	6,753	-(17,555)	-(10,802)

*Reflects weights with superstructure facing forward

Working Range



51 - 236 ft.
(15.5 - 72 m)



154,300 lbs.
(70MT)

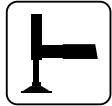

100%



360°

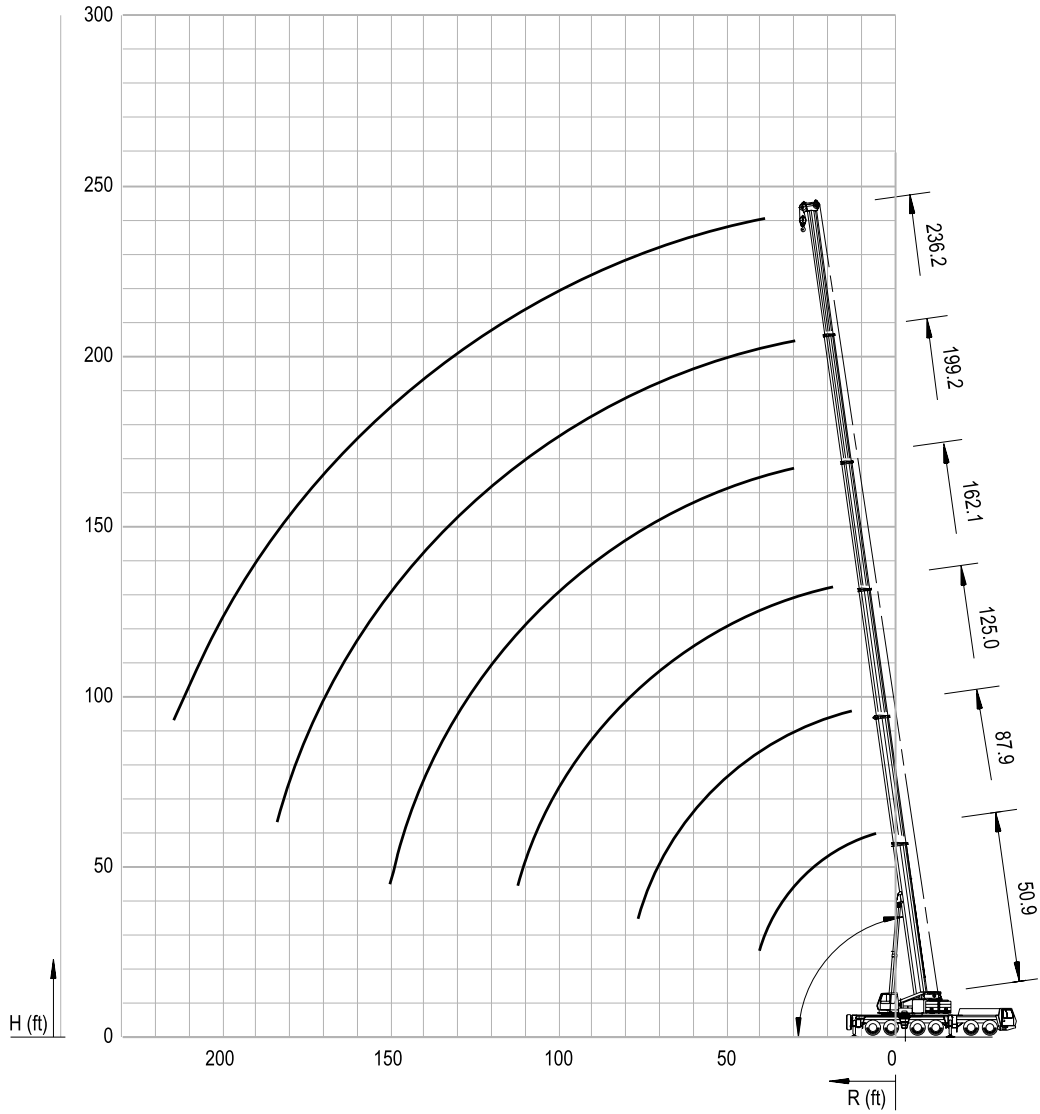

Superstructure Specifications

Boom

51 ft. - 236 ft. (15.5 m - 72 m) six section, full-power boom with patented TWIN-LOCK™ boom pinning system. Maximum tip height: 246 ft. (75 m)

Boom Elevation

Single lift cylinder with safety valve provides boom angle from -1.5° to +82°.

Lattice Extension

43 ft. - 72 ft. (13 m - 22 m) lattice swingaway extension. Hydraulically offsettable 5° - 40° with hydraulic luffing.

*Optional Lattice Jib Extension

Two 26 ft. (8 m) inserts for use with lattice swingaway extension to increase length up to 98 ft. (30 m) or 125 ft. (38 m).

Load Moment & Anti-Two Block System

Load moment and anti-two block system with audio/visual warning and control lever lockout provides electronic display of boom angle, length, radius, tip height, relative load moment, maximum permissible load, load indication and warning of impending two-block condition.

Cab

All aluminum construction cab is tiltable (approximately 20°) and includes safety glass and adjustable operator's seat with hydraulic suspension. Other features include engine dependent hot water heater, armrest integrated crane controls, and ergonomically arranged instrumentation.

Swing

Three swing gears with axial piston fixed displacement motors provide swing speed of 0 - 1.7 RPM thru planetary gear box. Also provided is a spring applied, hydraulically released automatic swing brake with foot-operated release for free swing.

Counterweight

154,300 lbs. (70 000 kg) consisting of various sections with hydraulic installation/removal system (See counterweight configuration on page 12).

Engine

Cummins 6BTA5.9-C, diesel, 6 cylinders, water-cooled, turbocharged, 165 HP (123 kW) at 2000 rpm. Max. torque: 538 ft. lbs. (730 Nm) at 1500 rpm. Engine emission: EUROMOT/EPA/CARB (off highway)

Fuel Tank Capacity

53 gal. (200 L)

Hydraulic System

Three separate circuits, 2 axial piston variable displacement pumps, with electronic power limiting control and 1 axial piston variable displacement pump for swing. Standard thermostatically controlled oil cooler keeps oil at optimum operating temperature. Tank capacity: 259 gal. (980 L)

Control System

Full electronic control of all crane movements is accomplished using electrical control levers with automatic reset to zero. Controls are integrated with the LMI and engine management system by CAN-BUS.

Hoist

Main and auxiliary hoist are powered by axial piston variable displacement motor with planetary gear and brake. "Thumb-thumper" hoist drum rotation indicator alerts operator of hoist movement.

	<u>Main</u>	<u>Auxiliary</u>
Line length:	984 ft. (300 m)	755 ft. (230 m)
Rope diameter:	22 mm	22 mm
Line speed:	426 ft./min.	426 ft./min.
Line pull:	21,000 lbs. (93.4 kN)	21,000 lbs. (93.4 kN)

Electrical System

24 V system with three-phase alternator 28 V/80 A, 2 batteries 12 V/170 Ah.

*Optional Equipment

- *Engine-independent hot water heater, with engine pre-heater
- *Second spotlight
- *Stereo/cassette player
- *Air conditioning
- *Mercedes-Benz engines
- *Stainless steel exhaust system

* Denotes optional equipment

Carrier Specifications

Chassis

Box-type, torsion resistant frame is fabricated from high-strength steel.

Outrigger System

Hydraulic two-stage outrigger beams are extended by a single hydraulic cylinder and two cables. Outriggers can adjust to two positions:

Fully extended (100%) - 27 ft. 11 in. (8.5 m)

Partially extended (50%) - 19 ft. 8 in. (6 m)

Four 29.5 in. x 32 in. (750 mm x 810 mm), self stowing, steel outrigger pads provide rigid lifting base.

Outrigger controls are located on both sides of the carrier. An electronic level indicator is located next to each outrigger control box.

Engine

Cummins N14-525 E+, diesel, 6 cylinders, water-cooled, turbocharged, 525 HP (392 kW) at 1800 rpm
Max. torque: 1850 ft. lbs. (2509 Nm) at 1200 rpm
Engine emission: EUROMOT/EPA/CARB (on highway)

Fuel Tank Capacity

132 gal. (500 L)

Transmission

Allison automatic CLT 755, 5 forward and 1 reverse speed. Transfer case with 2 speeds and inter-axle differential lock.

Drive/Steer

12 x 6 x 12

*12 x 8 x 12

Axles

6 axles. 1, 2, 4 and 5 are drive/steer. Axles 3 and 6 are steer only.

Suspension

GMK6250-L features the Grove exclusive MEGATRAK™ suspension. This revolutionary design features an independent hydropneumatic system with hydraulic lockout acting on all wheels. The suspension can be raised 6-1/2 in. (170 mm) or lowered 5 in. (130 mm) both longitudinally and transversely and features an automatic leveling system for on-highway travel.

Tires

12 tires, 20.5 R25

Steering

Dual circuit steering system is hydraulic power assisted with a transfer case mounted, ground driven, emergency steering pump. Axles 1, 2, 3, 5 and 6 steer on highway. Separate steering of the 4th, 5th and 6th axle for all wheel steer and crab-steer is controlled by an electric rocker switch.

Brakes

A dual circuit air system operates on all wheels with a spring-applied, air released parking brake acting on axles 2, 4, 5 and 6. An air dryer is fitted to remove moisture from the air system.

Auxiliary exhaust brake and constant throttle brake is standard.

Cab

Two-man, aluminum construction driver's cab includes the following features: safety glass; driver and passenger seats with hydraulic suspension, engine-dependent hot water heater, complete instrumentation and driving controls.

Electrical System

24 V system with three-phase alternator 28 V/100 A, 2 batteries 12 V/170 Ah.

Maximum Speed

48 mph (77km/h) with 20.5 R25 tires

Gradeability (Theoretical)

46% with 20.5 R25 tires

Miscellaneous Standard Equipment

Boom removal kit; trailing boom kit (less dolly); additional hydraulic oil cooler; spare tire and wheel - 20.5 R25 with carry bracket; flashing amber warning light on carrier cab; working light; tool kit; fire extinguisher; rooster sheave; radio cassette in carrier cab.

* Optional Equipment

- * Electric driveline retarder
- * 16.00 R25 tires (vehicle width 9 ft. 10 in. [3 m])
- * 14.00 R25 tires (vehicle width 9 ft. 9 in. [2.98 m])
- * Outrigger pressure measurement devices
- * Folding bunk bed in carrier cab
- * Engine-independent hot water heater, with engine pre-heater
- * Trailing boom "boost" weight transfer kit
- * Air conditioning
- * Mercedes-Benz engines

* Denotes optional equipment

51 - 236 ft. (15.5 - 72 m)		154,300 lbs. (70MT)		100% 27'11" Spread		360°		Pounds (thousands)														
Feet	50.9	69.4	87.9	106.5	125.0	143.5	162.1	180.6	199.2	217.7	236.2											
8	*406.0																					
10	382.0	308.0																				
15	288.0	272.0	208.0																			
20	238.0	228.0	208.0	157.0	120.0																	
25	200.0	196.0	188.0	157.0	120.0	93.0																
30	169.0	171.0	163.0	150.0	120.0	93.0	69.0	52.0														
35	140.0	147.0	143.0	139.0	118.0	93.0	69.0	52.0														
40		124.0	121.0	123.0	111.0	89.0	69.0	53.0	39.6	30.8												
45		107.0	104.0	106.0	103.0	84.0	65.0	52.0	39.6	30.8												
50		94.0	90.0	92.0	94.0	79.0	61.0	52.0	39.6	30.8	26.4											
55		81.0	79.0	81.0	83.0	75.0	58.0	50.0	39.6	30.8	26.4											
60			70.0	75.0	74.0	71.0	54.0	47.0	39.6	30.8	26.4											
65			62.0	68.0	67.0	67.0	50.0	43.8	39.2	30.8	26.4											
70			56.0	62.0	60.0	62.0	47.0	41.4	37.2	30.8	26.4											
75				56.0	55.0	57.0	44.0	39.0	35.4	30.8	26.4											
80				51.0	52.0	52.0	41.2	36.6	33.4	30.8	26.4											
85				47.0	48.0	47.0	38.2	34.2	31.6	29.4	26.4											
90				43.2	45.0	43.6	36.0	32.4	29.8	28.0	26.0											
95					42.0	40.2	34.0	30.4	28.2	26.6	25.2											
100					39.0	37.2	32.6	28.4	26.6	25.4	24.2											
105					36.4	34.6	31.4	26.4	25.0	24.0	22.8											
110					31.8	32.0	30.2	24.6	23.6	22.6	21.4											
115						29.8	29.0	22.6	22.0	21.2	20.0											
120						27.8	28.0	21.0	20.6	19.8	18.8											
125						26.0	27.0	20.0	19.0	18.4	18.0											
130						23.4	25.8	19.2	17.6	17.0	17.0											
135							24.2	18.6	16.6	16.2	16.2											
140							22.4	18.0	15.8	15.4	15.4											
145							20.2	17.4	15.0	14.6	14.6											
150							13.8	17.0	14.4	14.0	14.0											
155								16.4	13.8	13.4	13.2											
160								15.8	13.2	12.6	12.4											
165									12.6	12.0	11.8											
170									12.2	11.6	11.2											
175									11.8	11.2	10.6											
180									11.4	10.6	10.2											
185										10.2	9.6											
190										9.8	9.0											
195										9.2	8.4											
200										8.8	8.0											
205											7.6											
210											7.0											
215											6.2											

Loads >350,000 lb. can only be lifted with additional equipment
 *Over rear, 19.7 ft. outrigger span

51 - 236 ft. (15.5 - 72 m)		97,000 lbs. (44MT)		100% 27'11" Spread		360°		Pounds (thousands)														
Feet	50.9	69.4	87.9	106.5	125.0	143.5	162.1	180.6	199.2	217.7	236.2											
8	*406.0																					
10	382.0	308.0																				
15	288.0	272.0	208.0																			
20	238.0	228.0	208.0	157.0	120.0																	
25	188.0	190.0	186.0	157.0	120.0	93.0																
30	149.0	151.0	147.0	149.0	120.0	93.0	69.0	52.0														
35	122.0	124.0	121.0	123.0	118.0	93.0	69.0	52.0														
40		106.0	101.0	104.0	101.0	89.0	69.0	52.0	39.6	30.8												
45		92.0	86.0	92.0	86.0	84.0	65.0	52.0	39.6	30.8												
50		80.0	75.0	80.0	75.0	75.0	61.0	52.0	39.6	30.8	26.4											
55		70.0	65.0	70.0	70.0	66.0	58.0	50.0	39.6	30.8	26.4											
60			56.0	62.0	63.0	58.0	54.0	47.0	39.6	30.8	26.4											
65			49.0	55.5	56.0	52.0	48.0	43.8	39.2	30.8	26.4											
70			45.0	50.0	51.0	47.0	43.6	41.4	37.2	30.8	26.4											
75				47.0	46.0	42.0	41.4	37.2	35.4	30.8	26.4											
80				42.4	41.4	38.0	39.2	33.4	33.4	30.8	26.4											
85				38.4	37.2	34.4	35.8	30.0	30.2	29.4	26.4											
90				34.8	33.6	32.4	32.6	28.2	27.2	27.6	26.0											
95					30.2	31.0	29.8	27.0	24.6	25.0	25.2											
100					27.4	29.6	27.4	25.6	23.2	23.8	23.6											
105					25.4	27.0	24.8	24.4	22.2	22.6	21.6											
110					24.4	24.6	22.6	23.0	21.0	21.4	19.6											
115						22.6	20.4	21.4	20.0	20.2	18.0											
120						20.8	18.8	19.4	18.8	18.6	16.4											
125						19.0	18.0	17.8	17.8	17.0	15.0											
130						17.4	17.4	16.2	16.8	15.8	13.6											
135							16.8	14.8	15.2	14.4	12.4											
140							15.4	14.0	14.0	13.2	11.2											
145							14.4	13.4	13.2	12.0	10.2											
150							13.2	12.8	12.2	11.0	9.2											
155								12.0	11.0	9.8	8.2											
160								11.0	10.0	9.0	7.4											
165									9.2	8.0	6.4											
170									8.4	7.2	5.6											
175									7.6	6.4	4.8											
180									6.8	5.6	4.0											
185										4.8	3.4											
190										4.2	2.6											
195										3.6	2.6											
200										3.0	2.6											

Loads >350,000 lb. can only be lifted with additional equipment
 *Over rear, 19.7 ft. outrigger span

THIS CHART IS ONLY A GUIDE AND SHOULD NOT BE USED TO OPERATE THE CRANE. The individual crane's load chart, operating instructions and other instructional plates must be read and understood prior to operating the crane.

Working Range



51 - 236 ft.
(15.5 - 72 m)



43 - 125 ft.
(13 - 38 m)



154,300 lbs.
(70MT)

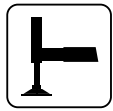

100%



360°

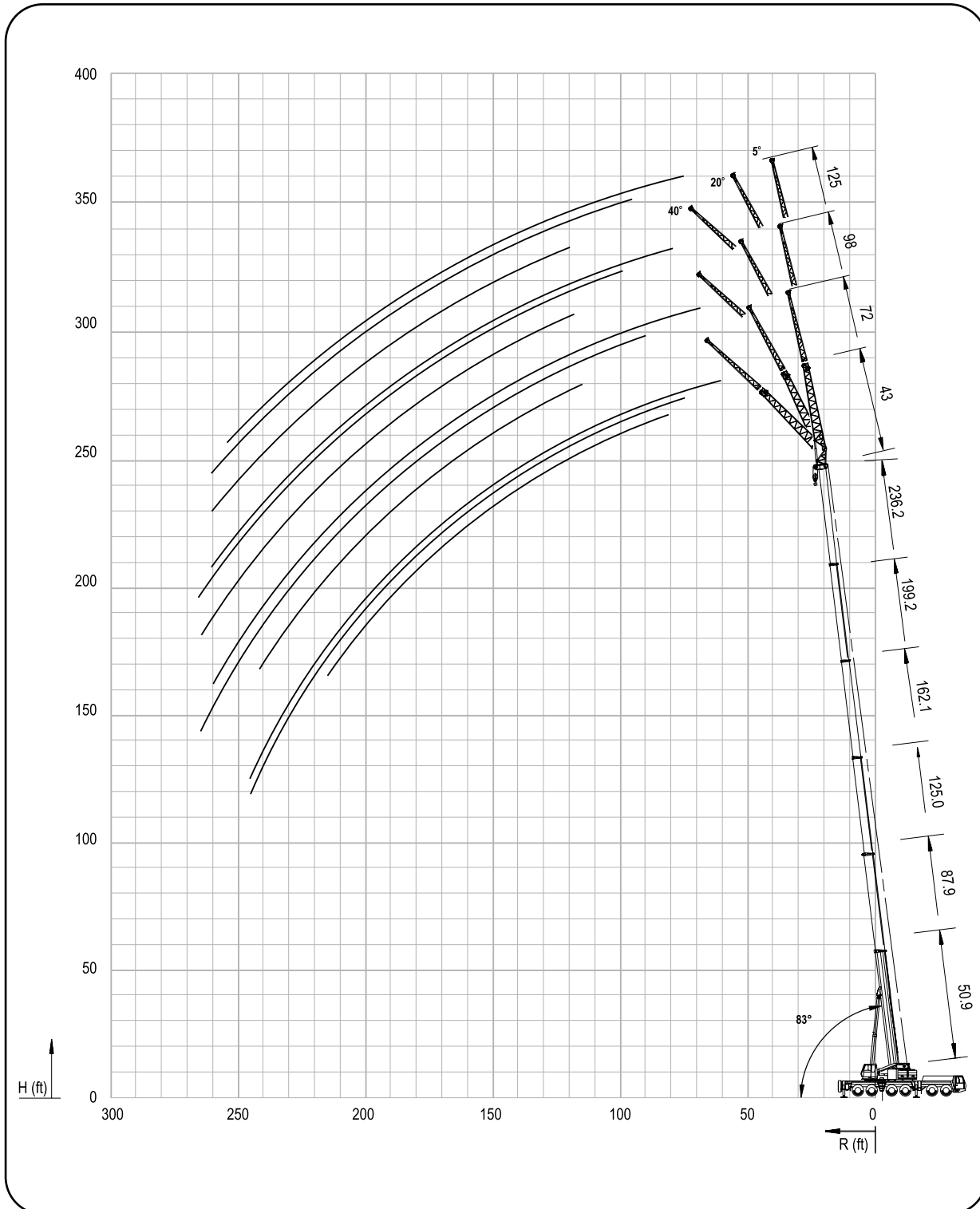



236 ft.
(72 m)



43-72-98-125 ft.
(13-22-30-38 m)



154,300 lbs.
(70MT)



100%
27'11" Spread



360°



Pounds (thousands)

Feet	43 FT			72 FT			98 FT			125 FT		
	5°	20°	40°	5°	20°	40°	5°	20°	40°	5°	20°	40°
50	13.8											
55	13.8											
60	13.8	13.6		9.0								
65	13.8	13.6		9.0								
70	13.8	13.6		9.0								
75	13.8	13.6	13.6	9.0			6.6					
80	13.8	13.6	13.6	9.0	8.6		6.6			4.4		
85	13.8	13.6	13.6	9.0	8.6		6.6			4.4		
90	13.8	13.6	13.6	9.0	8.6		6.6	6.6		4.4		
95	13.8	13.6	13.6	9.0	8.6		6.6	6.6		4.4	4.4	
100	13.8	13.6	13.6	9.0	8.6	8.6	6.6	6.6		4.4	4.4	
105	13.8	13.6	13.6	9.0	8.6	8.6	6.6	6.6		4.4	4.4	
110	13.8	13.6	13.6	9.0	8.6	8.6	6.6	6.6		4.4	4.4	
115	13.8	13.6	13.6	9.0	8.6	8.6	6.6	6.6	6.6	4.4	4.4	
120	13.8	13.6	13.6	9.0	8.6	8.6	6.6	6.6	6.6	4.4	4.4	4.2
125	13.8	13.6	13.6	9.0	8.6	8.6	6.6	6.6	6.6	4.4	4.4	4.2
130	13.4	13.4	13.6	9.0	8.6	8.6	6.6	6.6	6.6	4.4	4.4	4.2
135	13.0	13.0	13.2	9.0	8.6	8.6	6.6	6.6	6.6	4.4	4.4	4.2
140	12.6	12.6	12.8	9.0	8.6	8.6	6.6	6.6	6.6	4.4	4.4	4.2
145	12.2	12.2	12.4	9.0	8.6	8.6	6.6	6.6	6.6	4.4	4.4	4.2
150	11.8	11.8	12.0	9.0	8.6	8.6	6.6	6.6	6.6	4.4	4.4	4.2
155	11.4	11.2	11.6	9.0	8.6	8.6	6.6	6.6	6.6	4.4	4.4	4.2
160	10.8	10.8	11.2	9.0	8.6	8.6	6.6	6.6	6.6	4.4	4.4	4.2
165	10.2	10.4	10.8	9.0	8.6	8.6	6.6	6.6	6.4	4.4	4.4	4.2
170	9.8	9.8	10.2	8.8	8.6	8.6	6.6	6.6	6.4	4.4	4.2	4.2
175	9.2	9.4	9.8	8.4	8.6	8.6	6.6	6.4	6.4	4.4	4.2	4.2
180	8.6	8.8	9.4	8.2	8.4	8.4	6.4	6.2	6.2	4.2	4.2	4.2
185	8.2	8.4	9.0	7.8	8.0	8.2	6.2	6.2	6.0	4.2	4.2	4.2
190	7.6	8.0	8.4	7.4	7.8	8.0	6.0	6.0	6.0	4.2	4.0	4.2
195	7.2	7.6	8.0	7.2	7.4	7.8	5.8	5.8	5.8	4.2	4.0	4.0
200	6.8	7.0	7.4	6.8	7.2	7.6	5.6	5.8	5.8	4.0	4.0	4.0
205	6.4	6.6		6.4	6.8	7.4	6.4	5.6	5.6	4.0	4.0	4.0
210	6.0	6.2		6.0	6.6	7.2	5.0	5.2	5.4	4.0	3.8	4.0
215	5.6	5.8		5.8	6.2	6.8	4.8	5.0	5.2	3.8	3.8	4.0
220	5.2	5.4		5.4	6.0	6.4	4.6	4.8	5.2	3.8	3.8	3.8
225	4.6	4.8		5.0	5.6	6.0	4.4	4.6	5.0	3.4	3.6	3.8
230	4.0	4.2		4.8	5.2		4.0	4.4	4.8	3.2	3.4	3.6
235	3.4	3.6		4.4	4.8		3.8	4.2	4.6	3.0	3.2	3.4
240	2.8	3.0		4.0	4.4		3.6	4.0	4.2	2.8	3.2	3.4
245		2.6		3.6	4.0		3.2	3.6	4.0	2.6	3.0	3.2
250				3.2	3.6		3.0	3.4		2.4	2.8	3.0
255				2.8	3.2		2.6	3.0		2.2	2.6	3.0
260				2.2	2.6			2.6		2.4	2.6	2.6



236 ft.
(72 m)



43-72-98-125 ft.
(13-22-30-38 m)



154,300 lbs.
(70MT)



100%
27'11" Spread



360°



Pounds (thousands)

Feet	43 FT		72 FT		98 FT		125 FT		
	5°-20°	20°-40°	5°-20°	20°-40°	5°-20°	20°-40°	5°-20°	20°-40°	
55									
60	13.2								
65	13.2								
70	13.2								
75	13.2	13.6							
80	13.2	13.6		8.6					
85	13.2	13.6		8.6					
90	13.2	13.6		8.6					
95	13.2	13.6		8.6		6.6			
100	13.2	13.6		8.6	8.2	6.6		4.4	
105	13.2	13.6		8.6	8.2	6.6		4.4	
110	13.2	13.6		8.6	8.2	6.6		4.4	
115	13.2	13.6		8.6	8.2	6.6	6.6	4.4	
120	13.2	13.6		8.6	8.2	6.6	6.6	4.4	4.2
125	13.2	13.4		8.6	8.2	6.6	6.6	4.4	4.2
130	12.8	13.0		8.6	8.2	6.6	6.6	4.4	4.2
135	12.4	12.6		8.6	8.2	6.6	6.6	4.4	4.2
140	12.0	12.2		8.6	8.2	6.6	6.6	4.4	4.2
145	11.6	11.8		8.6	8.2	6.6	6.6	4.4	4.2
150	11.2	11.4		8.6	8.2	6.6	6.6	4.4	4.2
155	10.8	11.0		8.6	8.2	6.6	6.6	4.4	4.2
160	10.2	10.6		8.6	8.2	6.6	6.6	4.4	4.2
165	9.8	10.2		8.4	8.2	6.6	6.4	4.4	4.2
170	9.4	9.8		8.4	8.2	6.6	6.4	4.2	4.2
175	9.0	9.4		8.2	8.2	6.4	6.4	4.2	4.2
180	8.4	9.0		8.0	8.0	6.2	6.2	4.2	4.2
185	8.0	8.4		7.6	7.8	6.2	6.0	4.2	4.2
190	7.6	8.0		7.4	7.6	6.0	6.0	4.0	4.2
195	7.2	7.6		7.2	7.4	5.8	5.8	4.0	4.0
200	6.8	7.0		6.8	7.2	5.8	5.8	4.0	4.0
205	6.4			6.6	7.0	5.6	5.6	4.0	4.0
210	5.8			6.2	6.8	5.2	5.4	3.8	4.0
215	5.2			6.0	6.4	5.0	5.2	3.8	4.0
220	4.6			5.6	6.0	4.8	5.2	3.8	3.8
225	4.2			5.2	5.6	4.6	5.0	3.6	3.8
230	3.6			4.8		4.4	4.8	3.4	3.6
235	3.2			4.4		4.2	4.6	3.2	3.4
240	2.6			3.8		3.8	4.2	3.2	3.4
245	2.2			3.4		3.4	4.0	3.0	3.2
250				3.0		3.0		2.8	3.0
255				2.4		2.6		2.4	3.0
260									2.6
265									

THIS CHART IS ONLY A GUIDE AND SHOULD NOT BE USED TO OPERATE THE CRANE. The individual crane's load chart, operating instructions and other instructional plates must be read and understood prior to operating the crane.



236 ft.
(72 m)



43-72-98-125 ft.
(13-22-30-38 m)



97,000 lbs.
(70MT)



100%
27'11" Spread



360°



Pounds (thousands)

Feet	43 FT			72 FT			98 FT			125 FT		
	5°	20°	40°	5°	20°	40°	5°	20°	40°	5°	20°	40°
50	13.8											
55	13.8											
60	13.8	13.6		9.0								
65	13.8	13.6		9.0								
70	13.8	13.6		9.0			6.6					
75	13.8	13.6	13.6	9.0			6.6			4.4		
80	13.8	13.6	13.6	9.0	8.6		8.6			4.4		
85	13.8	13.6	13.6	9.0	8.6		8.6			4.4		
90	13.8	13.6	13.6	9.0	8.6		8.6	6.6		4.4		
95	13.8	13.6	13.6	9.0	8.6		8.6	6.6	6.6	4.4	4.4	
100	13.8	13.6	13.6	9.0	8.6	8.6	8.6	6.6	6.6	4.4	4.4	
105	13.8	13.6	13.6	9.0	8.6	8.6	8.6	6.6	6.6	4.4	4.4	
110	13.8	13.6	13.6	9.0	8.6	8.6	8.6	6.6	6.6	4.4	4.4	
115	13.8	13.6	13.6	9.0	8.6	8.6	8.6	6.6	6.6	6.6	4.4	4.4
120	13.8	13.6	13.6	9.0	8.6	8.6	8.6	6.6	6.6	6.6	4.4	4.4
125	13.8	13.6	13.6	9.0	8.6	8.6	8.6	6.6	6.6	6.6	4.4	4.4
130	12.6	13.4	13.6	9.0	8.6	8.6	8.6	6.6	6.6	6.6	4.4	4.4
135	11.4	12.4	13.2	9.0	8.6	8.6	8.6	6.6	6.6	6.6	4.4	4.4
140	10.2	11.2	12.0	9.0	8.6	8.6	8.6	6.6	6.6	6.6	4.4	4.4
145	9.2	10.0	10.8	9.0	8.6	8.6	8.6	6.6	6.6	6.6	4.4	4.4
150	8.2	9.0	9.8	9.0	8.6	8.6	8.6	6.6	6.6	6.6	4.4	4.4
155	7.2	8.0	8.6	8.6	8.6	8.6	8.6	6.6	6.6	6.6	4.4	4.4
160	6.4	7.2	7.8	7.8	8.6	8.6	8.6	6.6	6.6	6.6	4.4	4.4
165	5.6	6.2	6.8	7.0	8.2	8.6	8.6	6.6	6.6	6.4	4.4	4.4
170	4.8	5.4	6.0	6.2	7.4	8.6	8.6	6.0	6.6	6.4	4.4	4.2
175	4.2	4.6	5.2	5.4	6.6	7.8	8.6	5.2	6.4	6.4	4.4	4.2
180	3.4	4.0	4.4	4.8	5.8	7.0	8.6	4.6	5.8	6.2	4.2	4.2
185	2.8	3.2	3.6	4.0	5.2	6.2	8.6	3.8	5.0	6.0	3.6	4.2
190	2.2	2.6	3.0	3.4	4.4	5.4	8.6	3.2	4.4	5.4	3.0	4.0
195			2.4	2.8	3.8	4.6	8.6	2.6	3.8	4.6	2.4	3.4
200				2.2	3.2	4.0	8.6		3.0	4.0		2.8
205					2.6	3.4	8.6		2.6	3.4		2.2
210						2.8	8.6			2.8		2.6
215							8.6			2.2		



236 ft.
(72 m)



43-72-98-125 ft.
(13-22-30-38 m)



97,000 lbs.
(70MT)



100%
27'11" Spread



360°



Pounds (thousands)

Feet	43 FT		72 FT		98 FT		125 FT	
	5°-20°	20°-40°	5°-20°	20°-40°	5°-20°	20°-40°	5°-20°	20°-40°
55								
60	13.2							
65	13.2							
70	13.2							
75	13.2	13.6						
80	13.2	13.6	8.6					
85	13.2	13.6	8.6					
90	13.2	13.6	8.6		6.6			
95	13.2	13.6	8.6		6.6		4.4	
100	13.2	13.6	8.6	8.2	6.6		4.4	
105	13.2	13.6	8.6	8.2	6.6		4.4	
110	13.2	13.6	8.6	8.2	6.6		4.4	
115	13.2	13.6	8.6	8.2	6.6	6.6	4.4	
120	13.2	13.6	8.6	8.2	6.6	6.6	4.4	4.2
125	13.2	13.4	8.6	8.2	6.6	6.6	4.4	4.2
130	12.6	13.0	8.6	8.2	6.6	6.6	4.4	4.2
135	11.4	12.6	8.6	8.2	6.6	6.6	4.4	4.2
140	10.2	11.8	8.6	8.2	6.6	6.6	4.4	4.2
145	9.2	10.8	8.6	8.2	6.6	6.6	4.4	4.2
150	8.2	9.8	8.6	8.2	6.6	6.6	4.4	4.2
155	7.2	8.8	8.6	8.2	6.6	6.6	4.4	4.2
160	6.4	7.8	7.8	8.2	6.6	6.6	4.4	4.2
165	5.6	6.8	7.0	8.2	6.6	6.4	4.4	4.2
170	4.8	6.0	6.2	7.4	6.0	6.4	4.2	4.2
175	4.2	5.2	5.4	6.6	5.2	6.4	4.2	4.2
180	3.4	4.4	4.8	5.8	4.6	5.8	4.2	4.2
185	2.8	3.8	4.0	5.2	3.8	5.0	3.6	4.2
190		3.2	3.4	4.4	3.2	4.4	3.0	4.0
195		2.4	2.8	3.8	2.6	3.8	2.4	3.4
200			2.2	3.2		3.0		2.8
205				2.6		2.6		2.2

THIS CHART IS ONLY A GUIDE AND SHOULD NOT BE USED TO OPERATE THE CRANE. The individual crane's load chart, operating instructions and other instructional plates must be read and understood prior to operating the crane.

Boom Extension Configurations

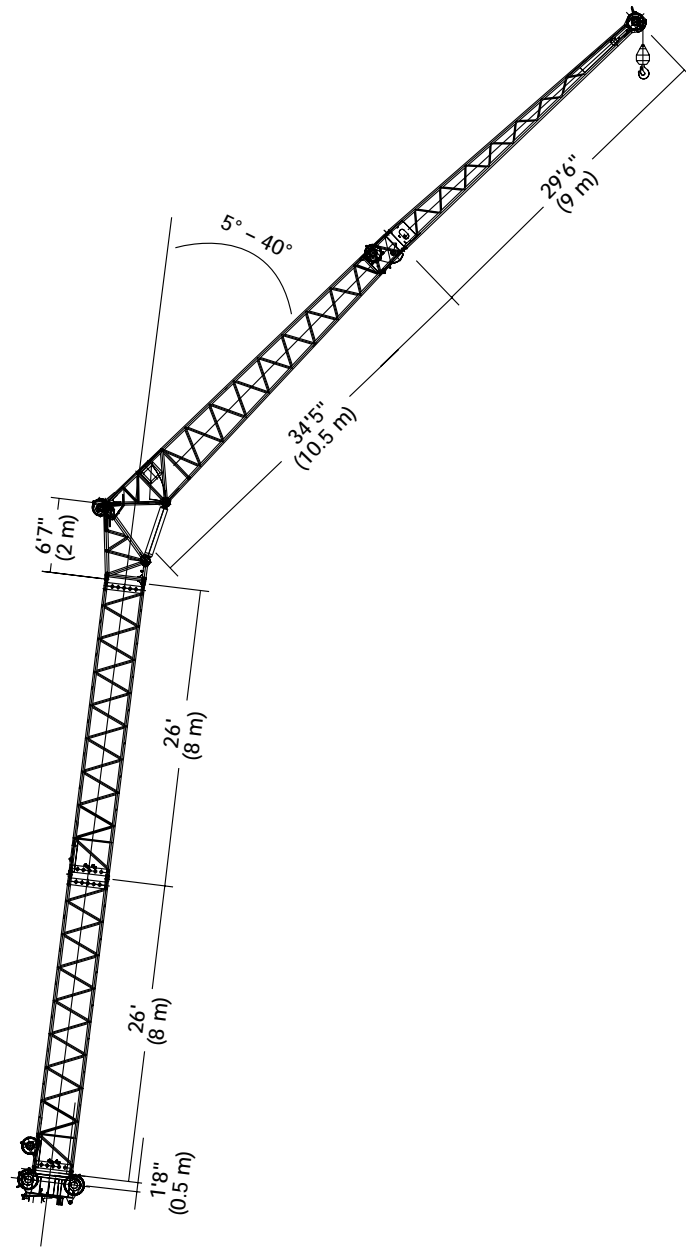

Length (ft.)	Intermediate section boom extension make-up			
	26' (8 m)	6'7" (2 m)	34'5" (10.5 m)	29'6" (9 m)
43	—	1x	1x	—
72	—	1x	1x	1x
98	1x	1x	1x	1x
125	2x	1x	1x	1x

Counterweight Configurations

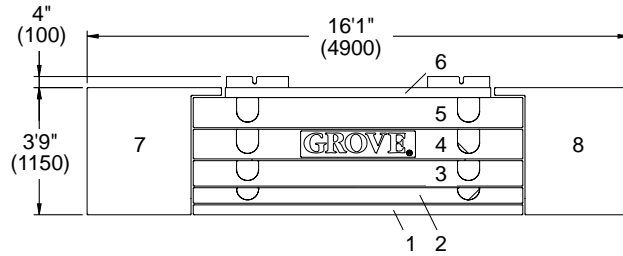

1. 11,980 lbs. (5 400 kg)

2. 11,200 lbs. (5 100 kg)

3. 18,700 lbs. (8 500 kg)

4. 24,300 lbs. (11 000 kg)

5. 23,100 lbs. (10 500 kg)

6. 7,700 lbs. (3 500 kg)

7. 28,660 lbs. (13 000 kg)

8. 28,660 lbs. (13 000 kg)

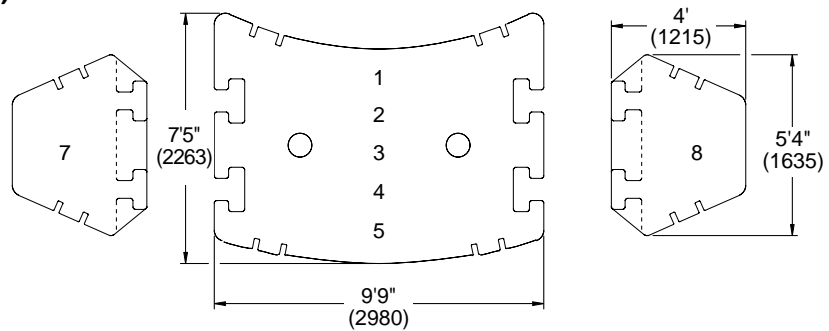
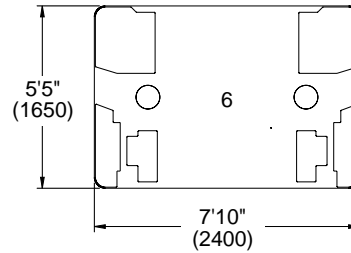
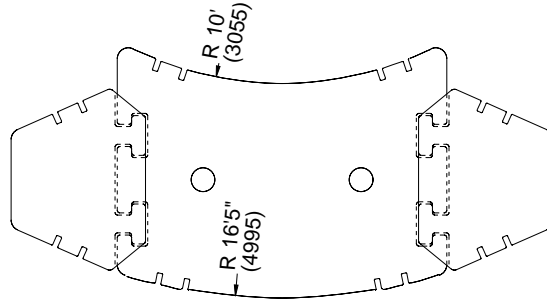

Note: () Reference dimensions in mm

	1	2	3	4	5	6	7	8
23,100 lbs.	X	X						
30,800 lbs.	X	X				X		
49,600 lbs.	X	X	X			X		
73,800 lbs.	X	X	X	X		X		
97,000 lbs.	X	X	X	X	X	X		
141,000 lbs.	X	X	X	X	X	X	*	*
154,300 lbs.	X	X	X	X	X	X	X	X

*NOTE: To utilize 141,000 lb. (64 000 kg) load chart optional counterweights for 7 & 8 may be provided weighing 22,050 lbs. (10 000 kg) each.

Rated Lifting Capacities

IMPORTANT NOTES:

WARNING: THIS CHART IS ONLY A GUIDE.

The notes below are for illustration only and should not be relied upon to operate the crane. The individual crane's load chart, operating instructions and other instruction plates must be read and understood prior to operating the crane.

1. All rated loads up to 420,000 pounds meet ANSI/ASME B30.5, Mobile and Locomotive Cranes. Testing and development were performed to SAEJ1063, Cantilevered Boom Crane Structures - Method of Test and SAEJ765 Crane Stability Test Code.

2. Capacities given do not include the weight of hook blocks, slings, auxiliary lifting equipment and load handling devices. Their weights must be added to the load to be lifted. When more than minimum required reeving is used, the additional rope weight shall be considered part of the load.

3. The machine shall be leveled on a firm supporting surface. Depending on the nature of the supporting surface, it may be necessary to have structural supports under the outrigger floats to spread the load to a larger bearing surface.

4. When either boom length or radius or both are between values listed, the smallest load shown at either the next larger radius or next longer or shorter boom length shall be used.

5. For outrigger operation, outriggers shall be properly extended with tires raised off the ground before operating the boom or lifting loads.



































† Comparative Rating

A rating designation based upon the premise that large capacity European cranes are typically purchased and used as long boom, high reach, long radius lift cranes, not as heavy lift cranes.

To provide a GMK 6250-L crane with the necessary equipment to achieve maximum lift capacity will drastically reduce long boom performance.

Therefore, augmenting lifting equipment is required for buyers who require such capacities.

Symbols Glossary

	Frame		Steering
	Outriggers		Transmission
	Outrigger Controls		Axles
	Engine		Brakes
	Fuel Tank Capacity		Tires
	Electrical System		Suspension
	Drive		Rotation
	Lights		Boom Elevation
	Cab		Swing
	Boom		Counterweight
	Fixed Swingaway		Oil
	Tele-Swingaway		Hydraulic System
	Lattice Extension (Luffing)		Hoist
	Boom Nose		Radius
	Boom Extension		Boom Length
	Speed		Hookblock
	Grade		Gear
	Lattice Extension		Luffing Jib

GMK6250-L Features and Benefits



▶ MEGATRAK™ independent suspension and all wheel steer system allows all wheels to remain on the ground at all times so stresses and weight are not continually transferred between axles

▶ ECOS (Electronic Crane Operating System) computerized system continuously monitors and controls principle crane functions as programmed by an operator



▶ EKS4 electronic load moment indicator operates in conjunction with ECOS continuously displaying crane configuration and load moment data

▶ MEGAFORM™ incorporates a "U" shape boom design which forms a natural cradle position for boom sections which eliminates stiffeners thus reducing weight and increasing capacity

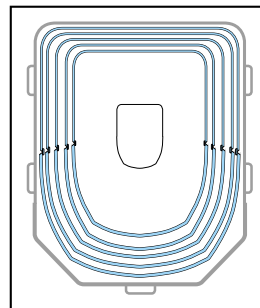

▶ TWIN-LOCK™ boom pinning mechanism automatically pins the sections in position using two horizontal large diameter boom pins

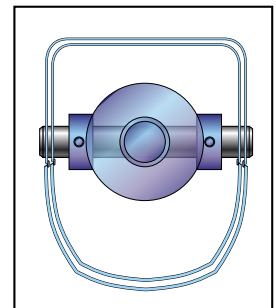

Constant improvement and engineering progress make it necessary that we reserve the right to make specification, equipment, and price changes without notice. Illustrations shown may include optional equipment and accessories and may not include all standard equipment.

GROVE® and GROVE LOGO are registered trademarks of GROVE in the U.S. and/or other countries. Copyright © 2000 GROVE. All rights reserved.

Grove Worldwide - World Headquarters

1565 Buchanan Trail East

P.O. Box 21

Shady Grove, Pennsylvania 17256-0021, U.S.A.

Tel: (717) 597-8121

Fax: (717) 597-4062

www.groveworldwide.com